

Rodamientos de rodillos cilíndricos tipo agujas

Los rodamientos de rodillos cilíndricos tipo agujas (en adelante rodamientos de agujas) son de pequeña altura en comparación con los de rodillos cilíndricos normales, por lo que se usan en maquinarias y equipos livianos y ligeros. Entre su amplio rango de aplicaciones, podemos mencionar: automoviles, motocicletas, máquinas eléctricas, máquinas manuales, maquinaria textil, equipos de imprenta, equipos aeroespaciales y de oficinas.

En los últimos años, las necesidades de automatización, ahorro de energía, reducción de peso y tamaño, y un funcionamiento a altas velocidades, han hecho que **Koyo** continuamente efectúe esfuerzos de mejoramiento de esta serie, al igual que de otras.

Si bien esta es una serie de rodamientos de producción común y un sistema de designación más acogido que otras series presentadas en este catálogo, la hemos incluido por su amplia aplicación en motores, transmisiones automáticas y manuales.

Entre sus características sobresalientes están:

Alta capacidad de carga

Comparada con rodamientos generales de bolas y rodillos, los rodamientos de agujas **Koyo** pueden asegurar una alta capacidad de carga en poco espacio, así como usarse sin aro interno o sin jaula, de tal forma que el diseño de la máquina puede ser reducido en tamaño y peso, resultando más compacto.

Sección transversal pequeña

Debido a su poca altura seccional, estos rodamientos pueden ajustar en casi el mismo espacio donde se aplica un cojinete de deslizamiento. Aunado a esto, su manejo y mantenimiento resultan fáciles.

Gran resistencia en operación a alta velocidad

En comparación con los rodamientos generales de bolas y rodillos, estos rodamientos de agujas tienen un menor diámetro del círculo primitivo. Como resultado, el aumento de la temperatura tiene poca influencia en la capacidad de carga y límite de velocidad, haciendo esto una ventaja en condiciones de alta velocidad.



Muchos rodillos-agujas

La carga es uniformemente distribuida y aplicada, asegurando así una gran capacidad de carga. En adición, esta combinación de muchos rodillos con diámetro pequeño, es una ventaja en rotaciones oscilantes.

Dentro de los rodamientos de rodillos cilíndricos tipo agujas, se distinguen:

- Jaulas de agujas.
- Casquillos de agujas.
- Rodamientos de agujas.
- Rodamientos axiales de agujas.
- Aros internos para rodamientos de agujas.
- Rodillos de apoyo con eje.

▶ RODAMIENTOS AUTOMOTRICES

Casquillos de agujas

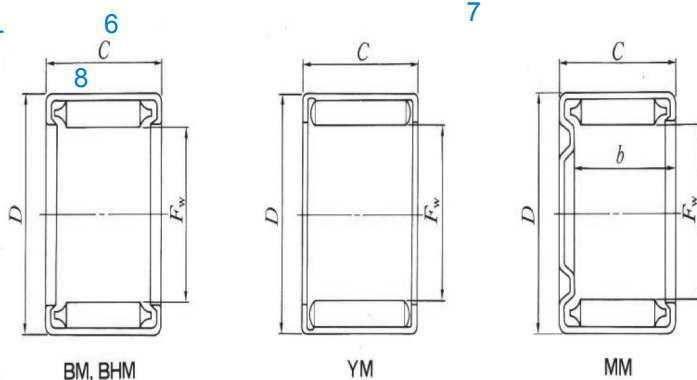

Jaula de agujas

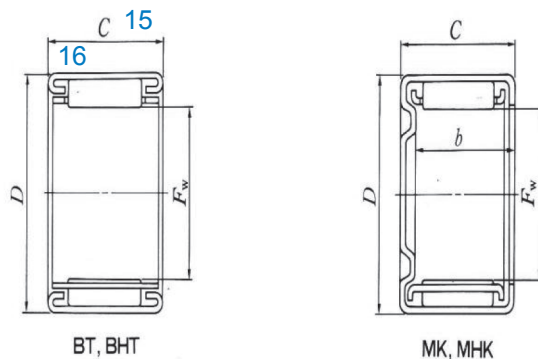
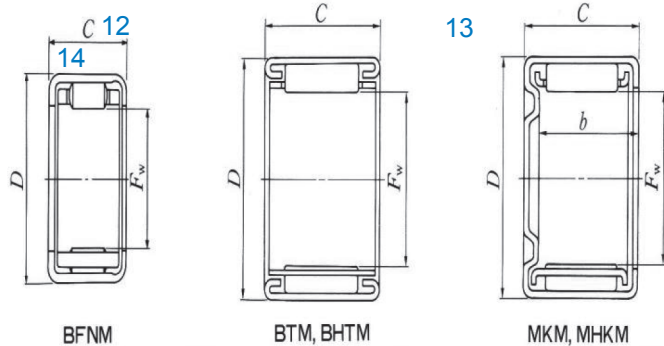
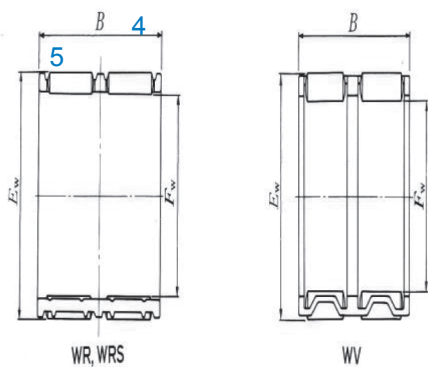
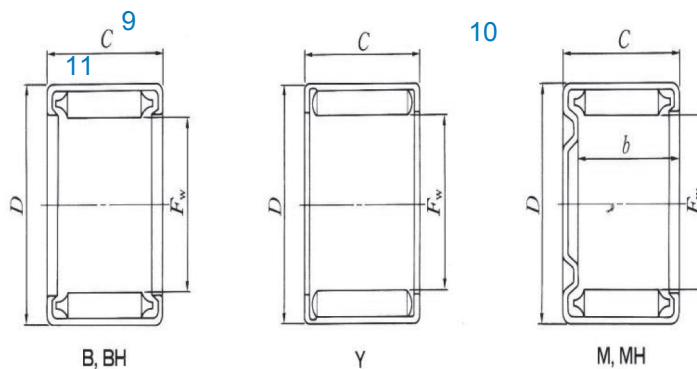
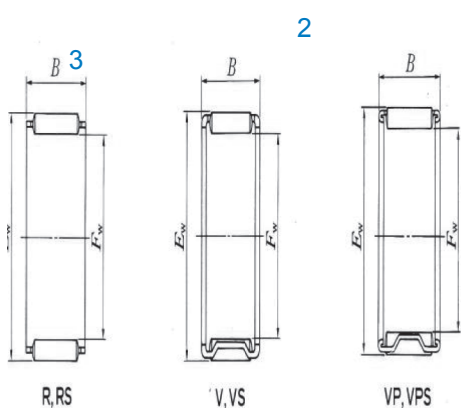

Rodamientos de agujas

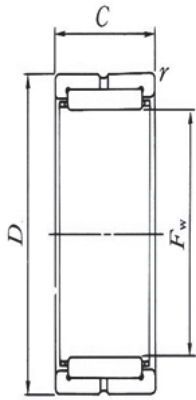

RNA49, RNA59

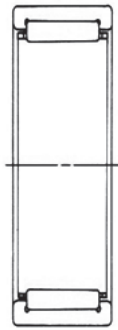

NQ, NQS

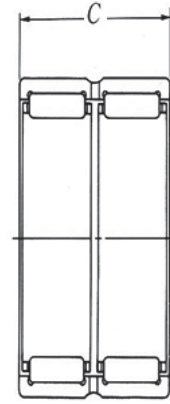

RNA69

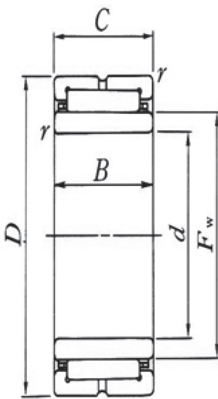

NA49, NA59



NQI, NQIS

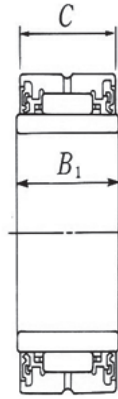

NA49..UU

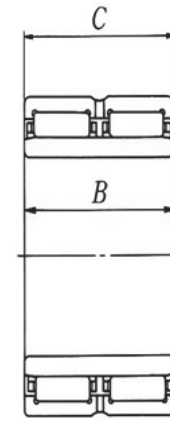

NA69

Rodamientos de agujas

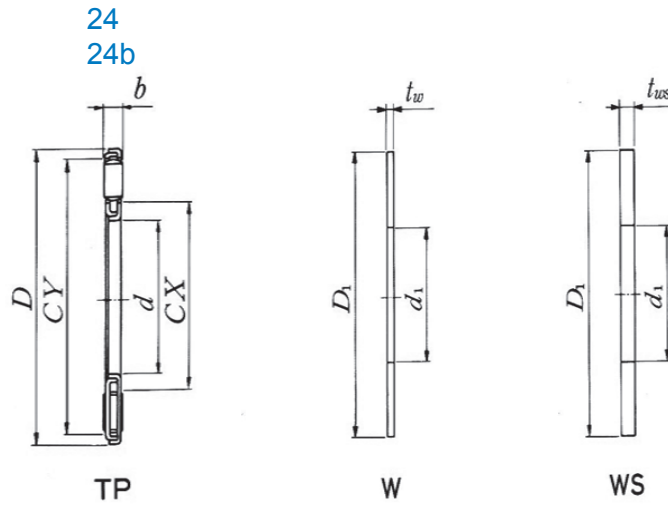





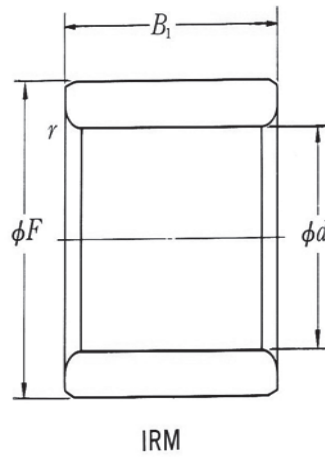













Rodamientos de agujas

25









IRM





Rodamientos de rodillos cilíndricos tipo "Agujas"							
Designación	Foto	Número de parte (O.E.M)	Fabricante	Aplicación /Comentario	Dimensiones Principales (mm)		
					d, Fw diám. int.	D, Ew Diám. ext.	B, C ancho a.e.
10BM1410		754-10010	N/D	DIRECCIÓN (eje sin-fin)/Cant. mín. requerida	10.00	14.00	10.00
10BTM1410		N/D	TOYOTA	TRANSMISIÓN	10.00	14.00	10.00
12BM1812		93315-212T0	YAMAHA	MOTOR FUERA DE BORDA	12.00	18.00	12.00
12BTM1610		91053-719-0040	HONDA	EJE PILOTO	12.00	16.00	10.00
12BTM1812		39333-940C1	TOYOTA	TRANSMISIÓN	12.00	18.00	12.00
13BTM2012J		N/D	N/D	DIRECCIÓN (eje sin-fin)	13.00	20.00	12.00
14BM2012		09263-M027	SUZUKI	MOTOCICLETA	14.00	20.00	12.00
15BTM2016C-2		N326-11-D03	MAZDA-Savanna	EJE PILOTO (Embrague-Transmisión)	15.00	20.00	16.00
15BTM2112-1		91106-383-000	HONDA	MOTOCICLETA	15.00	21.00	12.00
15BTM2116		N/D	YAMAHA	Motor Fuera/borda (Cant. mín.requerida)	15.00	21.00	16.00
15NQ2410D		93311-41530	YAMAHA	Motor fuera/borda	15.00	24.00	10.00
16BM2212		92046-1192	KAWASAKI	MOTOCICLETA	16.00	22.00	12.00
16BTM2216		09263-16006	SUZUKI	MOTOCICLETA	16.00	22.00	16.00
16YYM2213L		N/D	MITSUBISHI-Chariot, RVR	Cruceta de eje de propulsión/Drawn cup	16.00	22.00	13.42
17BM2312		93315-317U2	YAMAHA	MOTOR FUERA DE BORDA	17.00	23.00	12.00
17BM2312		93315-21721	YAMAHA	MOTOR FUERA DE BORDA	17.00	23.00	12.00
18BM2416		92046-1144	KAWASAKI	MOTOCICLETA	18.00	24.00	16.00
18VP2425B		0249-17-210A	MAZDA	TRANSMISIÓN	18.25	24.25	25.00
19VP2821A-1		M501-17-210	MAZDA	TRANSMISIÓN	18.00	27.00	21.00
19YM3607VH		90043-63244	DAIHATSU	TRANSMISIÓN	19.00	35.70	•
19YM3807VH		90364-19005	TOYOTA	TRANSMISIÓN	19.00	38.00	•
20BM2616		N/D	•	•	20.00	26.00	16.00
20BM2620		32283-14601	NISSAN	TRANSMISIÓN	20.00	26.00	20.00
20BTM2820A		HK2020	INA	Casq./Agujas-mm (estándar, sin fondo, con jaula)	20.00	28.00	•
20NQ3015ED		93311-220336	YAMAHA	MOTOR FUERA DE BORDA	20.00	30.00	15.00
20NQ3212		93311-62011	YAMAHA	MOTOR FUERA DE BORDA	20.00	32.00	12.00
20NQ3315NE		93311-42045	YAMAHA	MOTOR FUERA DE BORDA	20.00	33.00	15.00
20VS2612		N/D	•	CIGÜEÑAL	20.00	26.00	11.60
22BM2816		N/D	YAMAHA	•	22.00	28.00	16.00
22BM2820		93315-322U5	YAMAHA	MOTOR FUERA DE BORDA	22.00	28.00	20.00
22BTM2816A		92046-061	KAWASAKI	MOTOCICLETA	22.00	28.00	16.00
22BTM2820		09263-2203T	SUZUKI	MOTOCICLETA	22.00	28.00	20.00









Rodamientos de rodillos cilíndricos tipo "Agujas"

Designación	Foto	Número de parte (O.E.M)	Fabricante	Aplicación /Comentario	Dimensiones Principales (mm)		
					d, Fw diám. int.	D, Ew Diám. ext.	B, C ancho a.e.
23V3320-1		N/D	•	TRANSMISIÓN	23.00	33.00	20.00
23VS2814P		N/D	•	Jaula de agujas (1 hilera, alta capacidad)	23.00	28.00	14.00
25R3324B-1		8-94422-0691	ISUZU	TRANSMISIÓN	25.00	33.00	23.80
25UR3525A		9885-25104A	HINO	TRANSMISIÓN	25.00	35.00	24.50
25V3724		90364-25103	TOYOTA	TRANSMISIÓN	25.00	37.00	24.00
25VI4625		MH04480	MITSUBISHI	SUSPENSIÓN CAM	25.00	46.00	25.00
28BHM3730		42232-20504	TOYOTA	SISTEMA DE DIRECCIÓN	28.00	37.00	30.00
28BTM3516		5-09810-006	ISUZU	EJE DELANTERO	28.00	35.00	16.00
28BTM3516		5-09810-006	CHEVROLET	EJE DELANTERO	28.00	35.00	16.00
28BTM3516		90043-64095	DAIHATSU	TRANSMISIÓN	28.00	35.00	16.00
28BTM3516		93317-42086	YAMAHA	MOTOR FUERA DE BORDA	28.00	35.00	16.00
28NQ4020NRD		90369-28002	TOYOTA	TRANSMISIÓN	28.00	40.00	20.00
30BM3726		93315-430U8	YAMAHA	MOTOR FUERA DE BORDA	30.00	37.00	26.00
30BTM3720		93317-330U2	YAMAHA	MOTOR FUERA DE BORDA	30.00	37.00	20.00
30V4530		1-01811-017-0	ISUZU	TRANSMISIÓN	30.00	45.00	30.00
30VP3930A		90364-30006	TOYOTA	TRANSMISIÓN	30.00	39.00	30.00
30VS3720P		N/D	YAMAHA	BIELA MOTOCICLETA	30.00	37.00	20.00
30VU3921EP-1		93310-730V6	YAMAHA	MOTOR FUERA DE BORDA	30.00	39.00	21.00
31BTM3918A		09263-31009-000	SUZUKI	MOTOCICLETA	31.00	39.00	17.00
32BTM3811A		93315-23208	YAMAHA	BOMBA CENTRÍFUGA	32.00	38.00	11.00
32NQ4739BUW11		93311-63223	YAMAHA	MOTOR FUERA DE BORDA	32.00	47.00	38.00
32NQ4744BUW11		93311-632U0	YAMAHA	MOTOR FUERA DE BORDA	32.00	47.00	44.00
32YM4020PL		754-32060	TOYOTA	ARBOL DE LEVA	32.00	40.00	20.00
34R4238		90364-34060	TOYOTA	TRANSMISIÓN	34.00	42.00	38.00
34VP4440-1		N/D	TOYOTA	CAJA DE TRANSFERENCIA	34.00	44.00	40.00
34YM4225L		N/D	•	PIÑÓN TRASERO	34.00	42.00	25.00
35VP4135A		39694-2002	AISHIN	COMPRESOR	35.00	41.00	35.00
35VP4135A		29985-80050	SANDEN	COMPRESOR	35.00	41.00	35.00
35VP4140A		39694-2001	AISHIN	Jaula de agujas (estándar, 1 hilera)	35.00	41.00	40.00
35VP4140A		N/D	SANDEN	Jaula de agujas (estándar, 1 hilera)	35.00	41.00	40.00
36BM4216		N/D	FORD TRACTOR	TRANSMISIÓN	36.00	42.00	16.00
36NQ5238UNRW11		93311-636U6	YAMAHA	MOTOR FUERA DE BORDA	36.00	52.00	38.00
36NQ5238UW11		93310-636U4	YAMAHA	MOTOR FUERA DE BORDA	36.00	52.00	38.00









Rodamientos de rodillos cilíndricos tipo "Agujas"							
Designación	Foto	Número de parte (O.E.M)	Fabricante	Aplicación /Comentario	Dimensiones Principales (mm)		
					d, Fw diám. int.	D, Ew Diám. ext.	B, C ancho a.e.
36VU4621P-2-2		93310-836V2	YAMAHA	Motor fuera de borda/VENTA RESTRINGIDA	36.00	46.00	20.00
36YM4425L		90364-36005	TOYOTA	TRANSMISIÓN	36.00	44.00	25.00
37BTM4312A		N/D	ISUZU-Big Horn	Mecasnismo trasnsición 2 WD a 4WD	37.00	43.00	12.00
38IRM4840D		33355-87302	TOYOTA	TRANSMISIÓN	38.00	48.00	40.00
38VP5243		90364-38012	TOYOTA	CAJA DE TRANSFERENCIA	38.00	52.00	43.00
39WR4444		90364-39002	TOYOTA	TRANSMISIÓN	39.00	44.00	43.80
40BTM4720		9885-40108A	HINO	TRANSMISIÓN	40.00	47.00	20.00
40BTM4720		42006-70280	KAWASAKI	MOTOCICLETA	40.00	47.00	20.00
40NWQ6038A		93311-940U3	YAMAHA	Motor fuea/borda (nuevo 40NWQ6038AW11)	40.00	60.00	38.00
40NWQ6038AW11		93311-940U3	YAMAHA	Motor fuera/borda (antes 40NMQ6038A)	40.00	60.00	38.00
40V4834		9-00096-137-0	ISUZU	TRANSMISIÓN	40.00	48.00	34.00
40VPU4943B		90364-40001	TOYOTA	TRANSMISIÓN	40.00	48.00	34.00
42VPU5147		90364-42001	TOYOTA	TRANSMISIÓN	42.00	51.00	46.50
43VP4931E		90364-43002	TOYOTA	TRANSMISIÓN	43.00	49.00	31.00
43VP4931E		90364-43003	TOYOTA	TRANSMISIÓN	43.00	49.00	31.00
43VP4931E		90364-43004	TOYOTA	TRANSMISIÓN	43.00	49.00	31.00
43VP5240		90364-43005	TOYOTA	TRANSMISIÓN	43.00	52.00	40.00
48R5439		90043-64031	TOYOTA	TRANSMISIÓN	48.00	54.00	39.00
55BTM6320		N/D	GMC. Allison Transm.Div	Transm.autom-Camión (Eje de turbina)	55.00	63.00	20.00
55BTM6720A		N/D	•	•	55.00	67.00	20.00
58RFN6537A		N/D	TOYOTA-Lan Cruiser	2do.engranje transm./Jaula plástica	58.00	65.00	36.60
60V6723		9-00096-135-0	ISUZU	TRANSMISIÓN	60.00	67.00	23.00
B1212		7F7983	CATERPILLAR	Casquillo/Agujas-plg. (estándar, sin fondo, sin jaula)	19.05	25.40	19.05
B1412		09263-22020	YAMAHA	MOTOR FUERA DE BORDA	22.23	28.58	19.05
B1412		N/D	SUZUKI	MOTOR FUERA DE BORDA	22.23	28.58	19.05
B1616		7B5670	CATERPILLAR	Casquillo/Agujas-plg. (estándar, sin fondo, sin jaula)	25.40	31.75	25.40
B1816A		2/804152	FIAT	Casquillo/Agujas-plg. (estándar, sin fondo, sin jaula)	28.58	34.93	25.40
B188		J645664	MITSUBISHI	EJE DELANTERO	28.58	34.93	12.70
B2012		39330-8600	AISHIN	Casquillo/Agujas-plg. (estándar, sin fondo, sin jaula)	31.75	38.10	19.05
B2012		1J3710	AISHIN	Casquillo/Agujas-plg. (estándar, sin fondo, sin jaula)	31.75	38.10	19.05

Rodamientos de rodillos cilíndricos tipo "Agujas"

Designación	Foto	Número de parte (O.E.M)	Fabricante	Aplicación /Comentario	Dimensiones Principales (mm)		
					d, Fw diám. int.	D, Ew Diám. ext.	B, C ancho a.e.
B228		22490-001	SUMITOMO	Casquillo/Agujas-plg. (estándar, sin fondo, sin jaula)	34.93	41.28	12.70
B3216		93315-660W3	YAMAHA	MOTOR FUERA DE BORDA	50.80	60.33	25.40
BHM2530		N/D	KAWAJU	Casquillo-agujas (sin fondo ni jaula) Suspen.Motoc.	25.00	33.00	30.00
BHM3518		N/D	•	MONTACARGA	35.00	•	18.00
BHTM1015		N/D	•	•	10.00	17.00	15.00
BHTM1020		N/D	•	•	10.00	17.00	20.00
BHTM2515-1		N/D	AISINSEIKI	•	25.00	30.00	15.00
BHTM2520-1		N/D	BOSCH	•	25.00	33.00	20.00
BHTM2530		90364-25024	TOYOTA	TRANSMISIÓN	25.00	33.00	30.00
BHTM2620A		09263-26005	SUZUKI	TRANSMISIÓN	26.00	34.00	20.00
BHTM2620A		09263-26010	SUZUKI	TRANSMISIÓN	26.00	34.00	20.00
BM2015		N/D	•	Casquillo/Agujas-mm. (estándar, sin jaula, 1 hilera)	20.00	28.00	12.00
BM2516		93315-425V3	YAMAHA	Casquillo/Agujas-mm. (estándar, sin jaula, 1 hilera)	25.00	32.00	16.00
BM2520		N/D	•	Casquillo/Agujas-mm. (estándar, sin jaula, 1 hilera)	25.00	32.00	20.00
BM2526		93315-425U7	YAMAHA	MOTOR FUERA DE BORDA	25.00	32.00	26.00
BM283930A		N/D	•	•	28.00	39.00	30.00
BM3520		N/D	•	Casquillo de agujas-mm. (estándar, sin jaula, 1 hil.)	35.00	42.00	20.00
BSM152316EM		N/D	TOYOTA Crown	Compresor A/A Desplazamiento variable	15.00	23.00	16.00
BT1312		N/D	•	Casquillo/Agujas-plg. (estándar, con jaula, 1 hil.)	20.64	26.99	19.05
BT2012		MB160670	MITSUBISHI	EJE DELANTERO	31.75	38.10	19.05
BTM141912A		N/D	MITSUBISHI	MOTOR DE ARRANQUE	13.00	19.00	•
BTM1820		09263-18020-000	SUZUKI	Casq./Agujas-mm. (estándar, jaula, no fondo, 1 hil.)	18.00	25.00	20.00
BTM1820		90364-975D1	TOYOTA	Casq./Agujas-mm. (estándar, jaula, no fondo, 1 hil.)	18.00	25.00	20.00
BTM1820		90364-18007	TOYOTA	Casq./Agujas-mm. (estándar, jaula, no fondo, 1 hil.)	18.00	25.00	20.00
BTM182416		MB937107	MITSUBISHI	TRANSMISIÓN	18.00	24.00	•
BTM182416		N/D	YAMAHA	TRANSMISIÓN	18.00	24.00	•

Rodamientos de rodillos cilíndricos tipo "Agujas"							
Designación	Foto	Número de parte (O.E.M)	Fabricante	Aplicación /Comentario	Dimensiones Principales (mm)		
					d, Fw diám. int.	D, Ew Diám. ext.	B, C ancho a.e.
BTM2220A		N/D	•	Casq./Agujas-mm. (estándar, jaula, no fondo, 1 hil.)	22.00	29.00	20.00
BTM344017A		N/D	TOYOTA	TRANSMISIÓN	33.50	40.00	17.00
BTM3516		40588-C6000	NISSAN	EJE DELANTERO	35.00	42.00	16.00
BTM4020		93317-640U4	YAMAHA	MOTOR FUERA DE BORDA	40.00	50.00	20.00
BTM4520A		90369-45001	TOYOTA	TRANSFER	45.00	55.00	20.00
BWKM1840		90364-18006	TOYOTA	ACOPLE VENTILADOR	18.00	25.00	40.00
IRM303530CS40		N/D	•	Aro interno para rodamiento de agujas	30.00	35.00	30.00
NQ20/16D		MB532375	MITSUBISHI	Rodam.agujas(sin a.int., 1 hil.)/Sist.dirección	20.00	28.00	16.00
NQ24/20AD		N/D	•	Rodamiento de agujas (sin aro int., 1 hilera)	24.00	32.00	20.00
NQS22/20D		90364-22003	TOYOTA	TRANSMISIÓN	22.00	35.00	20.00
R18/16-8		91104-744-000	HONDA	SUSPENSIÓN	18.00	22.00	16.00
R18/17		91021-639-004	HONDA	Jaula de agujas (estándar, 1 hilera)	18.00	22.00	17.00
R32/17-1		N/D	N/D	Jaula de agujas (estándar, 1 hilera)	32.00	37.00	17.00
R36/31		9-00096-627	ISUZU	TRANSMISIÓN	36.00	41.00	30.50
R36/31		9-00096-633	ISUZU	TRANSMISIÓN	36.00	41.00	30.50
R40/30		1-09811-029-0	ISUZU	TRANSMISIÓN	40.00	45.00	30.00
R40/30		5-09811-011	ISUZU	TRANSMISIÓN	40.00	45.00	30.00
R40/30		90364-40054	TOYOTA	TRANSMISIÓN	40.00	45.00	30.00
R40/30		93306-34072	YAMAHA	MOTOR FUERA DE BORDA	40.00	45.00	30.00
R47/30H		9-00096-621	ISUZU	TRANSMISIÓN	47.00	52.00	30.00
R47/30H		9-00096-625	ISUZU	TRANSMISIÓN	47.00	52.00	30.00
R56/34		9-00096-636-0	ISUZU	TRANSMISIÓN	56.00	61.00	33.50
R56/34		9-00096-637-0	ISUZU	TRANSMISIÓN	56.00	61.00	33.50
R60/30		1-09811-020-0	ISUZU	TRANSMISIÓN	60.00	65.00	30.00
R63/30		1-09811-119-0	ISUZU	TRANSMISIÓN	63.00	68.00	30.00
R63/30		1-09811-199-0	ISUZU	TRANSMISIÓN	63.00	68.00	30.00
R75/20		2306-3235-30	HINO	TRANSMISIÓN	75.00	81.00	20.00
R75/20		9885-70102	HINO	TRANSMISIÓN	75.00	81.00	20.00
R75/20		9885-75102	HINO	TRANSMISIÓN	75.00	81.00	20.00
RF333923A		32264-70E02	NISSAN	TRANSMISIÓN	33.00	39.00	22.60
RF364125Z		8-97118-872-0	ISUZU	TRANSMISIÓN	36.00	41.00	25.00
RF384426		N/D	TOYOTA	Jaula-agujas (estándar, 1 hil., plástica) Suspens.	38.00	44.00	26.00

Rodamientos de rodillos cilíndricos tipo "Agujas"

Designación	Foto	Número de parte (O.E.M)	Fabricante	Aplicación /Comentario	Dimensiones Principales (mm)		
					d, Fw diám. int.	D, Ew Diám. ext.	B, C ancho a.e.
RF535825		MD744536	MITSUBISHI-FTO	Transmisión (jaula con agujas)	53.60	57.80	25.00
RFU253027A		90364-24006	TOYOTA	Jaula/agujas (estándar, 1 hilera, plástica, 2 partes)	24.90	29.90	26.80
RFU253027A		39694-093K3	TOYOTA	Jaula/agujas (estándar, 1 hilera, plástica, 2 partes)	24.90	29.90	26.80
RFU293424A-1		90364-29002	TOYOTA	Jaula/agujas (estándar, 1 hilera, plástica, 2 partes)	29.00	34.00	24.40
RFU313624A		antes 31RFNU3624	•	Jaula/agujas (estándar, 1 hilera, plástica, 2 partes)	31.00	36.00	24.40
RFU343920A		N/D	TOYOTA Yaris	Transmisión manual	34.00	39.00	20.30
RNA4906D		7141119350	KOMATSU	EJE CARDÁN	35.00	47.00	17.00
RNSFU547626W11		93310-954V3	YAMAHA	ESTACION DE ENERGÍA	54.00	72.00	26.00
RP193124A		N/D	•	TRANSMISIÓN	19.10	31.10	24.00
RP202619A		32272 15U00	NISSAN Silvia	Transmisión manual. Eng-suelto reversa	21.00	26.00	18.80
RP323826		90364-32017	TOYOTA	TRANSMISIÓN	32.00	38.00	26.00
RP354031		32264-V5200	NISSAN	TRANSMISIÓN	35.00	40.00	31.00
RP354033-1		32264-V5201	NISSAN	TRANSMISIÓN	35.00	40.00	33.00
RP384433		90364-38002	TOYOTA	TRANSMISIÓN	38.00	44.00	33.00
RP384440A		90364-38017	TOYOTA	Jaula de agujas (estándar, 1 hilera)	38.00	44.00	40.00
RP445039		90364-44065	TOYOTA	TRANSMISIÓN	44.00	50.00	39.00
RP455236A		N/D	•	Jaula de agujas (estándar, 1 hilera)	45.00	52.00	36.00
RP475329A		90364-47004	TOYOTA	TRANSMISIÓN	47.00	53.00	29.00
RP475336		90364-47003	TOYOTA	TRANSMISIÓN	47.00	53.00	36.00
RP505734A		N/D	•	Jaula de agujas (estándar, 1 hilera)	50.00	57.00	34.00
RP546036		90364-54001	TOYOTA	TRANSMISIÓN	54.00	60.00	36.00
RP586538A		N/D	•	Jaula de agujas (estándar, 1 hilera)	58.00	65.00	38.00
RPU263334F		90364-26001	TOYOTA	TRANSMISIÓN	26.00	33.00	34.00
RPU283538A		90364-28009	TOYOTA	TRANSMISIÓN	28.00	35.00	38.00
RPU374337F		90364-37012	TOYOTA	TRANSMISIÓN	37.00	43.00	37.00
RPU374337F		39694-019K9	TOYOTA	TRANSMISIÓN	37.00	43.00	37.00
RPU374337F		90364-37012-000	DAIHATSU	TRANSMISIÓN	37.00	43.00	37.00
RS17/13		N/D	•	Jaula de agujas (alta capacidad, 1 hilera)	17.00	23.00	13.00
RS182417		Antes RS18/17P	NISSAN	Jaula de agujas (alta capacidad, 1 hilera)	18.00	24.00	17.00
RS202630		N/D	NISSAN Skyline, Pick Up	Transmisión manual (engranaje)	20.00	26.00	30.00

Rodamientos de rodillos cilíndricos tipo "Agujas"

Designación	Foto	Número de parte (O.E.M)	Fabricante	Aplicación /Comentario	Dimensiones Principales (mm)		
					d, Fw diám. int.	D, Ew Diám. ext.	B, C ancho a.e.
RS22/17		6706114242	KUBOTA	Jaula de agujas (alta capacidad, 1 hilera)	22.00	28.00	17.00
RS30/20A		MD704121	MITSUBISHI	CAJA DE TRANSFERENCIA	30.00	37.00	20.00
RS354029A		N/D	•	•	35.00	40.00	28.90
RS434830		8-94422-065-1	ISUZU	Jaula-agujas(alta cap., 1 hil) Antes R43/30A	43.00	48.00	30.00
RV203121B		N/D	NISSAN-Skyline, Pick Up	Transmisión manual (engranaje)	20.00	31.42	21.30
RV406155A		N/D	HINO	Transmisión(engranaje suelto)	40.07	61.07	55.00
RVU323942		90364-32007	TOYOTA	Jaula de agujas (separable, 1 hilera)	32.00	39.00	42.00
TP2035		90374-20015	TOYOTA	SUSPENSIÓN, AMORTIGUADOR Jaula de agujas- axial.	20.00	35.00	b=2.0
TP2236A-1		N/D	TOYOTA	•	22.20	36.10	1.98
TP2542		90374-25004	AISHIN	SUSPENSIÓN, AMORTIGUADOR Jaula de agujas- axial.	25.00	42.00	b=2.0
TP2542A		N/D	•	MOTOR ELÉCTRICO	25.00	42.00	5.00
TP3047-1		90374-30001	TOYOTA	SUSPENSIÓN, AMORTIGUADOR Jaula de agujas- axial.	30.00	47.00	b=2.0
TP3047-1		N/D	KOKI	SUSPENSIÓN, AMORTIGUADOR Jaula de agujas- axial.	30.00	47.00	b=2.0
TP4060		N/D	•	SUSPENSIÓN, AMORTIGUADOR Jaula de agujas- axial.	40.00	60.00	b=3.0
TP5070		N/D	•	SUSPENSIÓN, AMORTIGUADOR Jaula de agujas- axial.	50.00	70.00	b=3.0
TPK2036J-1		N/D	TOYOTA Yaris	Transmisión automática	19.60	35.90	2.80
TPK3146JL-5		90374-30A003	TOYOTA-Corolla	Jaula de agujas-axial. (tipo no separable)	30.70	46.40	3.72
TVK2642J		90374-25A001	TOYOTA-Corolla	Jaula-agujas-axial (TV, no sep.)Antes TPK2642J	26.00	42.00	2.78
TVK2644J-1		N/D	TOYOTA	Transmisión automática	27.80	44.00	1.98
TVK5370Z		N/D	TOYOTA	Transmisión automática	54.30	70.60	4.10
TVW3869L		N/D	TOYOTA Crown	Compresor A/A Desplazamiento variable	38.00	69.00	4.00
TVWS1734FF-1		N/D	TOYOTA-LEXUS	COMPRESOR/Rodamiento axial	17.00	37.00	7.00
VP20/20-1		N/D	KUBOTA	TRANSMISIÓN	20.00	26.00	20.00
VP32/30A		N/D	•	TRANSMISIÓN	32.00	37.00	29.50
VP35/19		90364-35062	TOYOTA	TRANSMISIÓN	35.00	40.00	19.00
VP37/13A		90364-37002	TOYOTA	TRANSMISIÓN	37.00	42.00	12.80
VP37/17		90364-37050	TOYOTA	TRANSMISIÓN	37.00	42.00	17.30
VP37/17		90364-37050-000	DAIHATSU	TRANSMISIÓN	37.00	42.00	17.30
VP37/29		90364-37004	TOYOTA	TRANSMISIÓN	37.00	42.00	29.00

Rodamientos de rodillos cilíndricos tipo "Agujas"

Designación	Foto	Número de parte (O.E.M)	Fabricante	Aplicación /Comentario	Dimensiones Principales (mm)		
					d, Fw diám. int.	D, Ew Diám. ext.	B, C ancho a.e.
VP37/32		90043-64061	DAIHATSU	TRANSMISIÓN	37.00	42.00	32.00
VPS16/32		90364-16003	TOYOTA	TRANSMISIÓN	16.00	22.00	32.00
VPS16/32		N/D	DAIHATSU	TRANSMISIÓN	16.00	22.00	32.00
VPSU27/29AF		90364-27002	TOYOTA	TRANSMISIÓN	27.00	33.00	28.60
VS22/23B		9-00096-100-1	ISUZU	TRANSMISIÓN	22.00	28.00	23.00
VS22/23B		9-00096-601-0	ISUZU	TRANSMISIÓN	22.00	28.00	23.00
W1935L		2030-018006G	TOYOTA	Arandela axial (para jaula de agujas-axial)	19.00	35.00	t=1.0
W2542F		N/D	•	Arandela axial (para jaula de agujas-axial)	25.00	42.00	t=1.0
W2640AJ		35789-10A010	TOYOTA-Corolla	Arandela axial (para jaula de agujas-axial)	26.00	40.00	t=1.0
W3047F		N/D	•	Arandela axial (para jaula de agujas-axial)	30.00	47.00	t=1.0
W3552F		N/D	•	Arandela axial (para jaula de agujas-axial)	35.00	52.00	t=1.0
YM2825BL		N/D	MITSUBISHI L200	TRANSMISIÓN	28.00	34.00	25.00
YM2825BL		N/D	DATSUN NISSAN 1200cc-1600cc	TRANSMISIÓN	28.00	34.00	25.00

▶ RODAMIENTOS AUTOMOTRICES

RODAMIENTOS DE AGUJAS

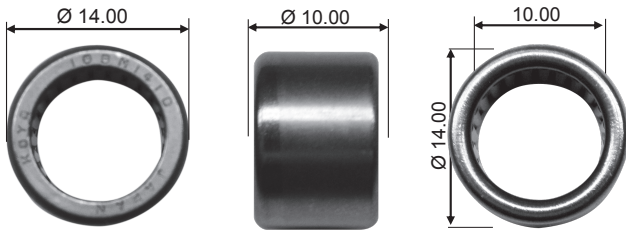

10BM1410

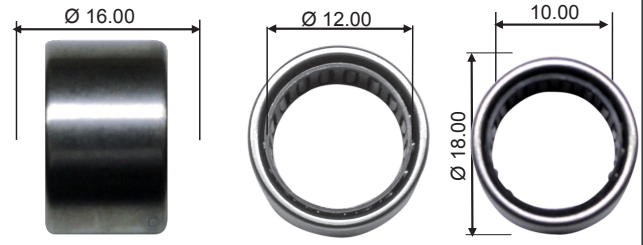

12BTM1610

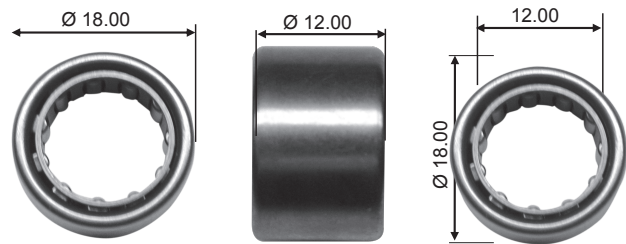

12BTM1812

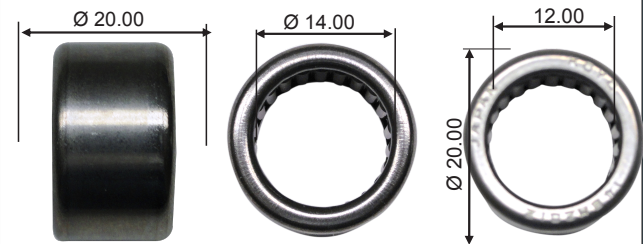

14BM2012



15BTM2016C-2

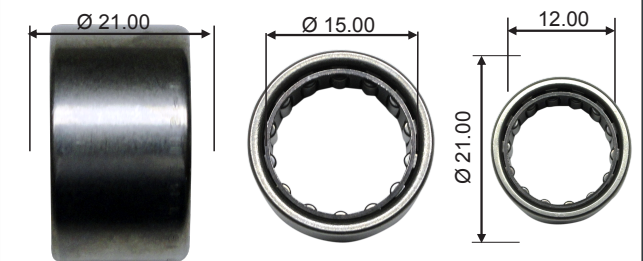

15BTM2112-1

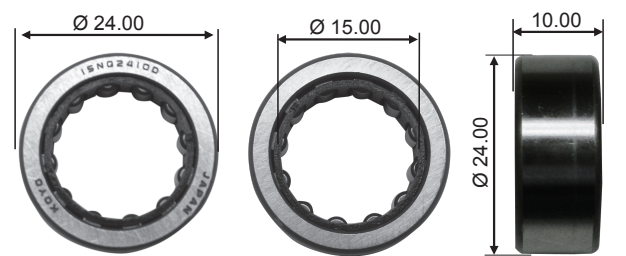

15NQ2410D

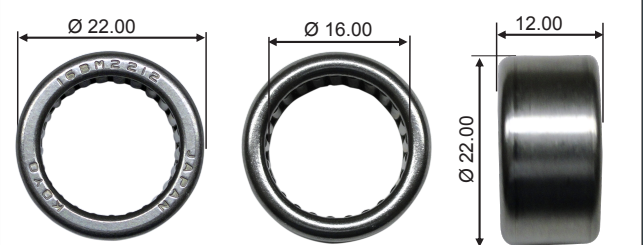

16BM2212